

REMEMBER TO INCLUDE **STAMPS** INFORMATION ABOUT YOUR SEALS: **SIZE, TEMPERATURE, APPLICATION, MEDIA, PRESSURE AND SPEED**

### ROD SEALS

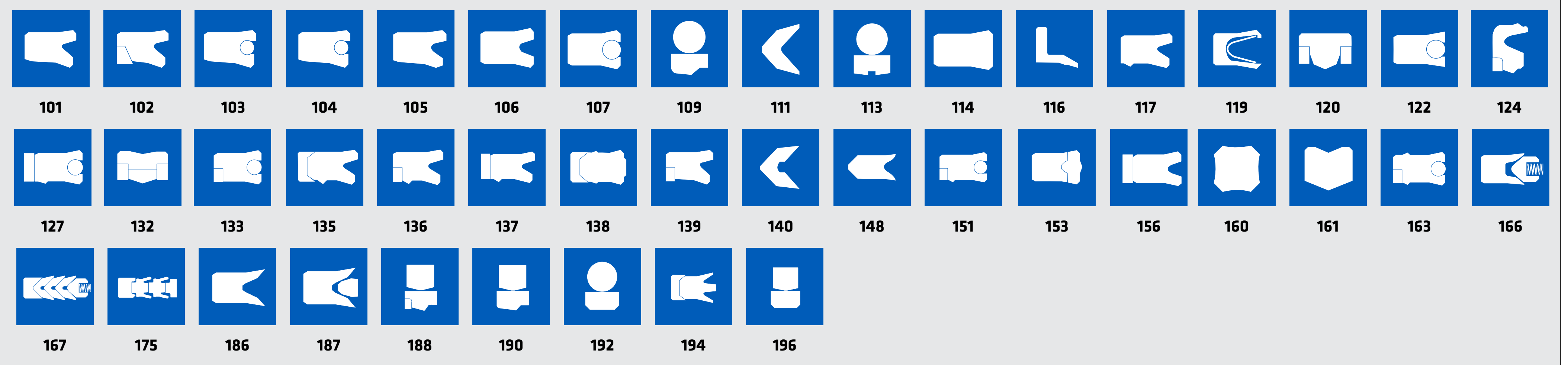

### PISTON SEALS

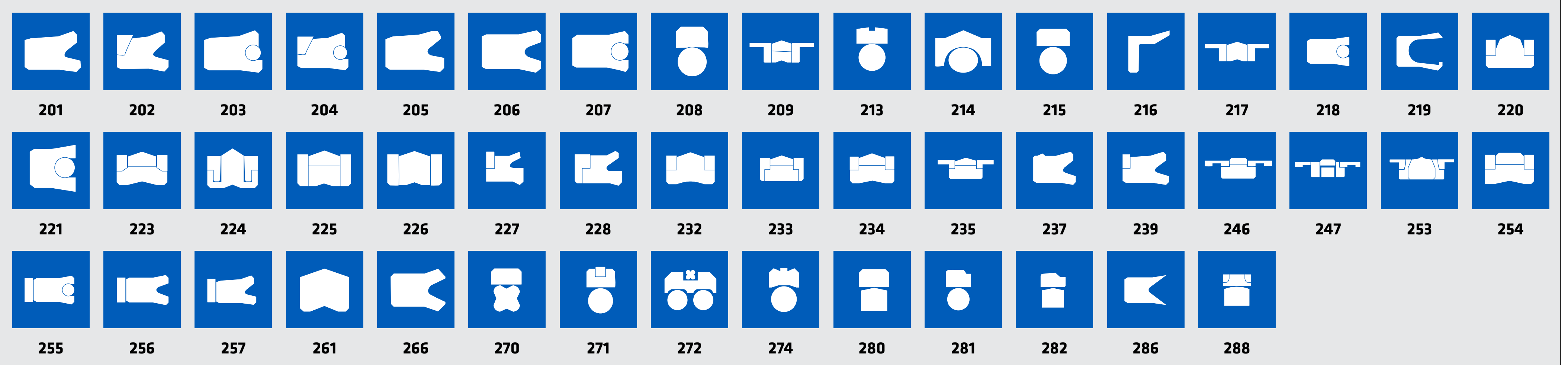

### WIPERS

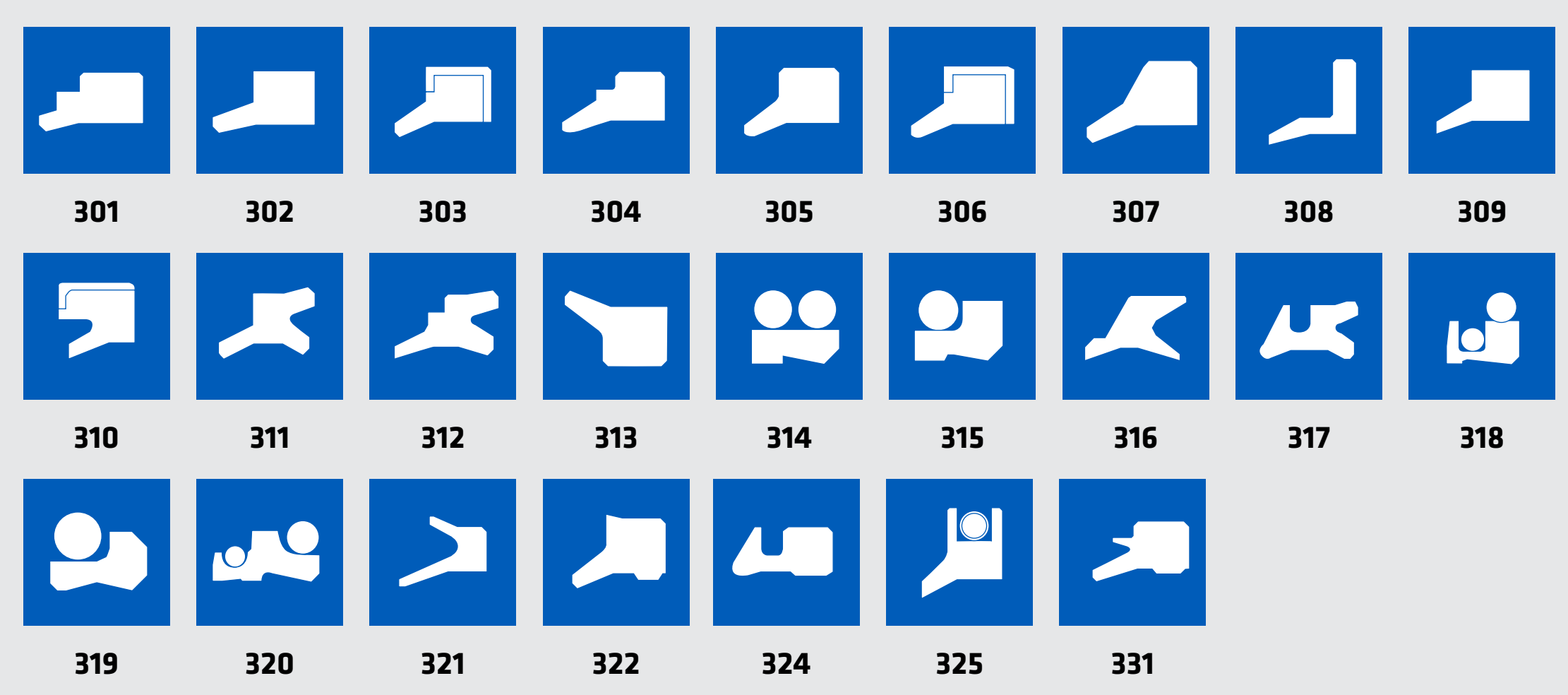

### FACE SEALS

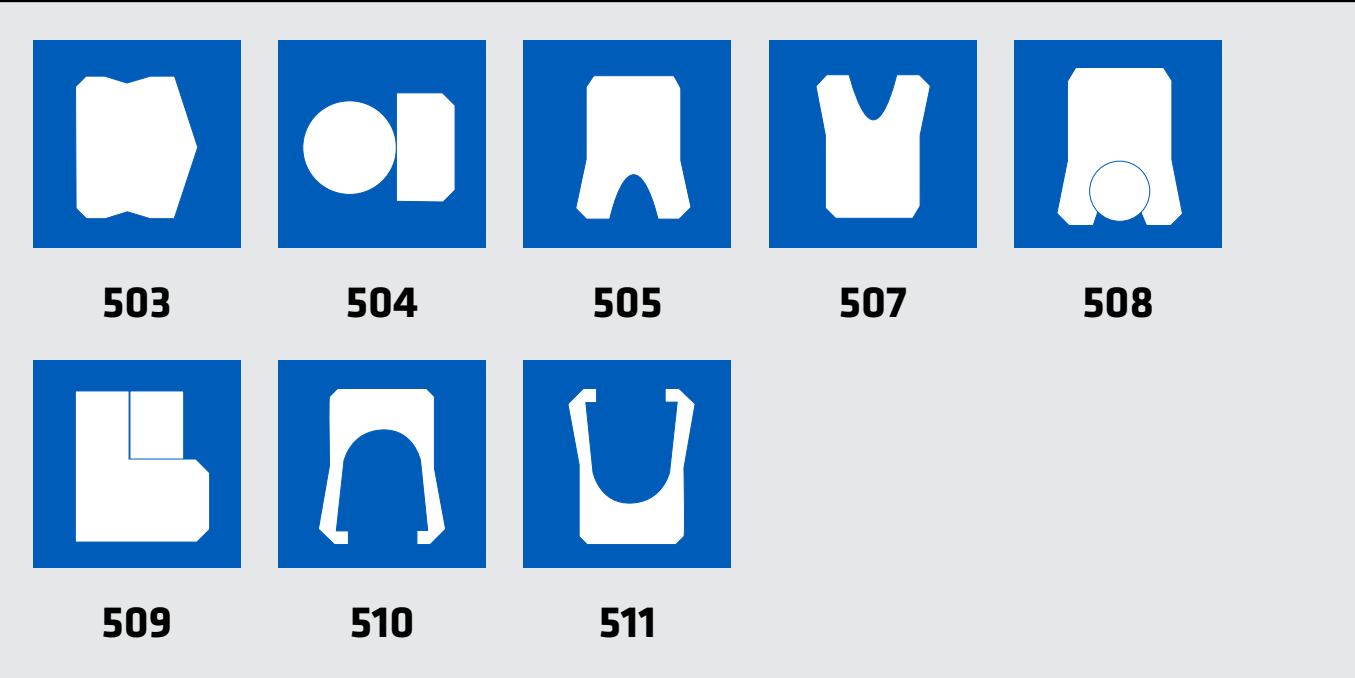

### BACK-UPS

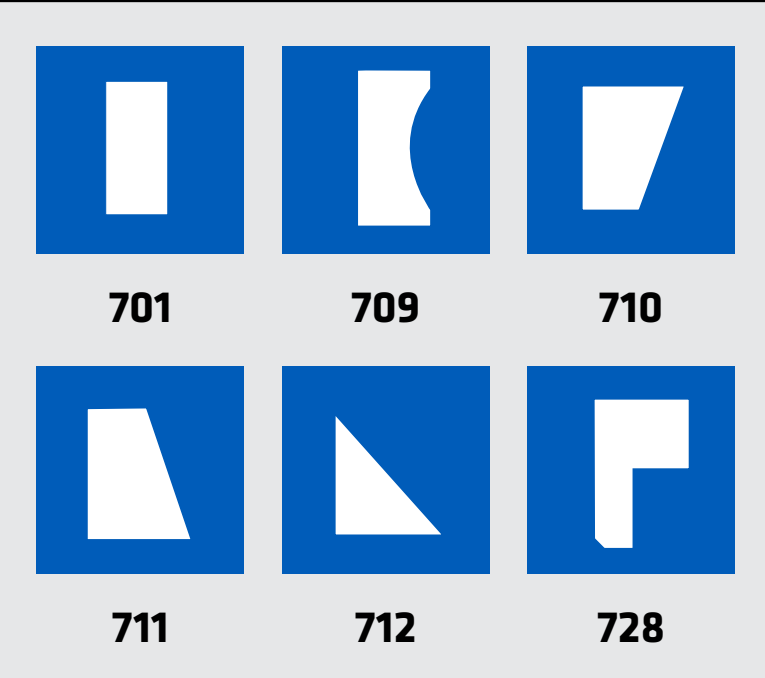

### ROTARY SEALS

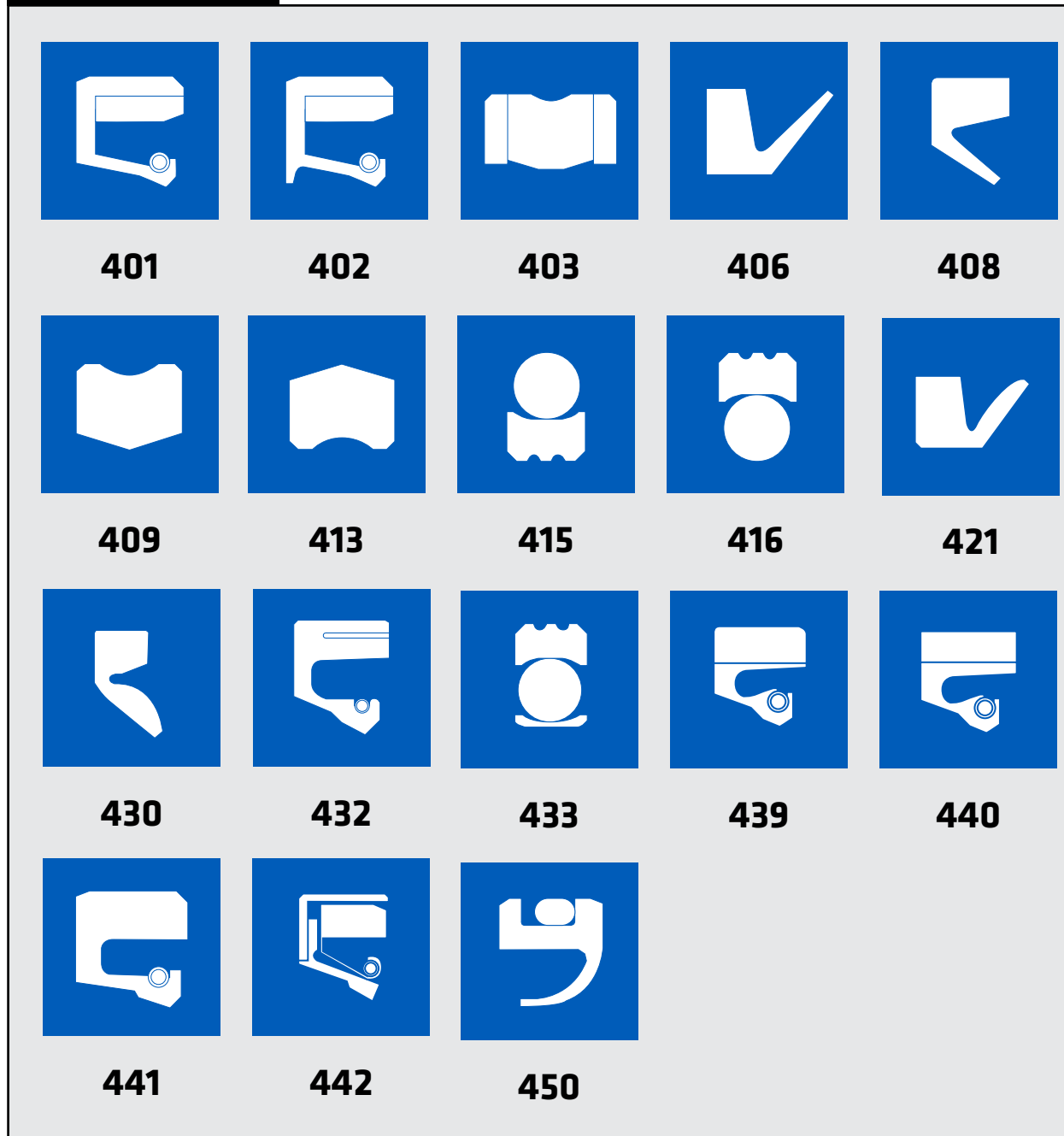

### O-RINGS

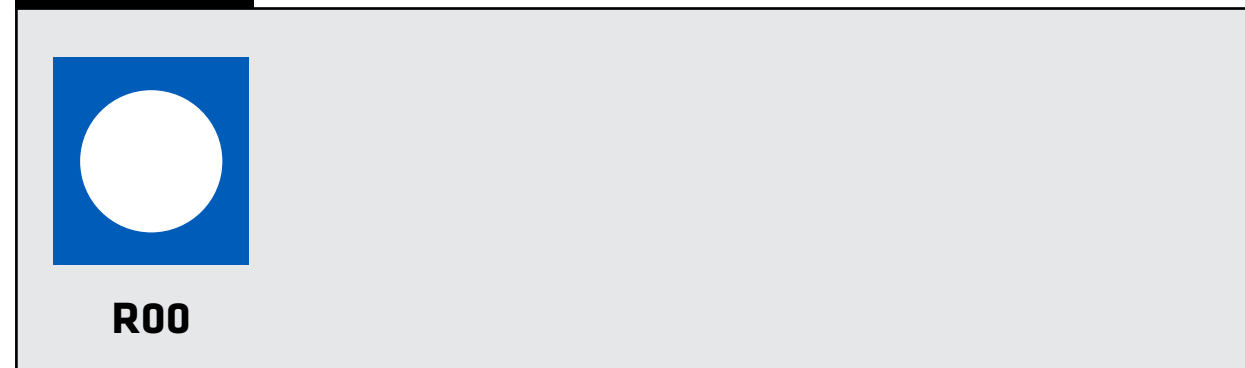

### GUIDE WEAR BANDS

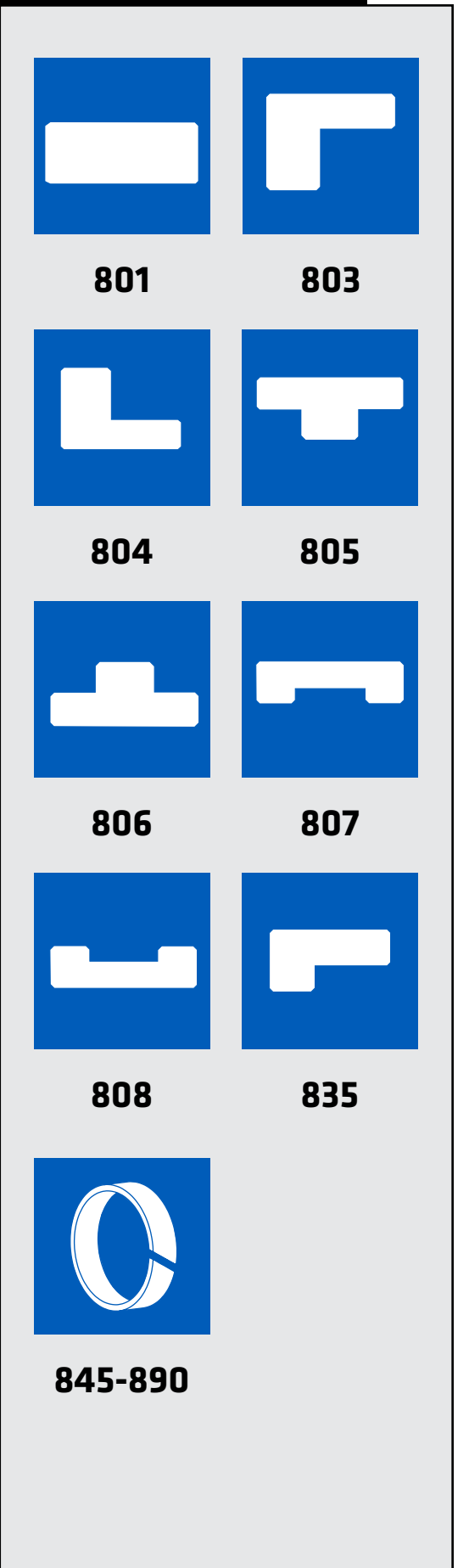

### MATERIALS AVAILABLE

POLYURETHANE (PU) / NBR / HNBR / FPM (VITON) / EPDM / SILICONE / PTFE COMPOUNDS / UHMWPE / ACETAL (POM) / POLYAMIDE (NYLON) / PEEK

### PISTON

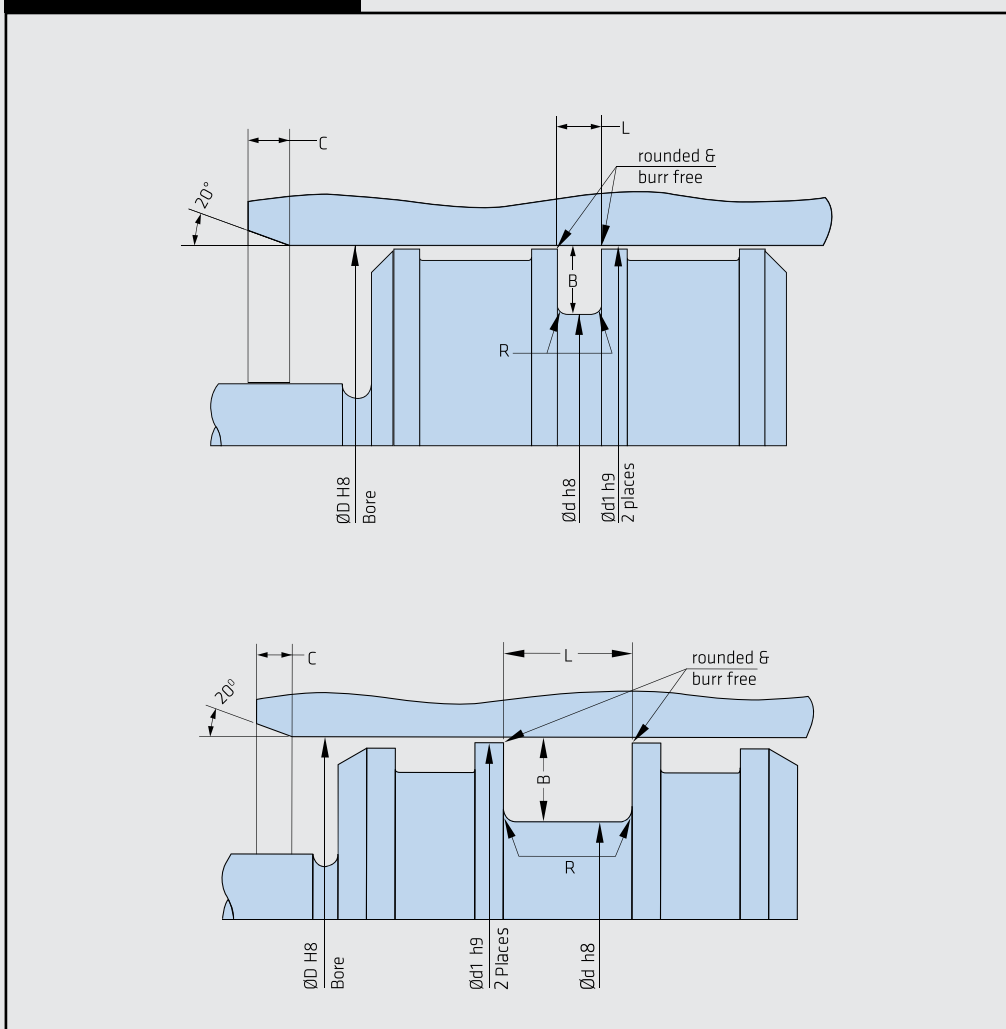

### ROD

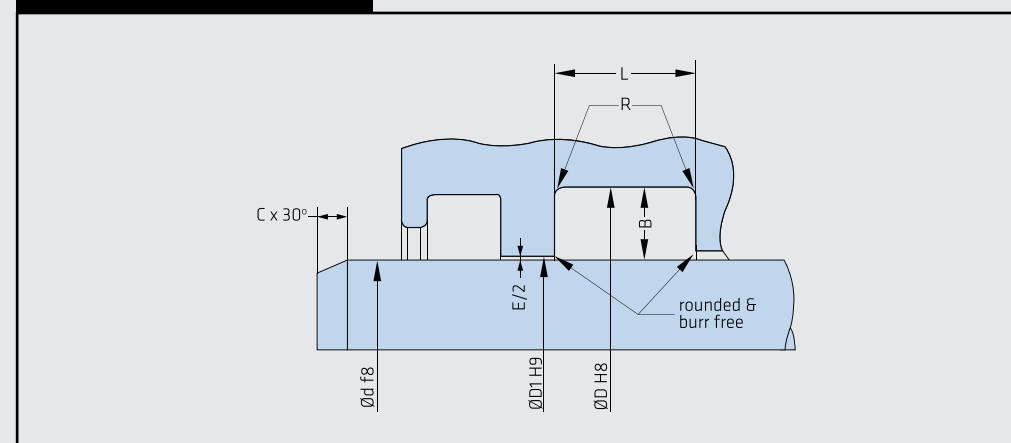

### GUIDE BAND - PISTON

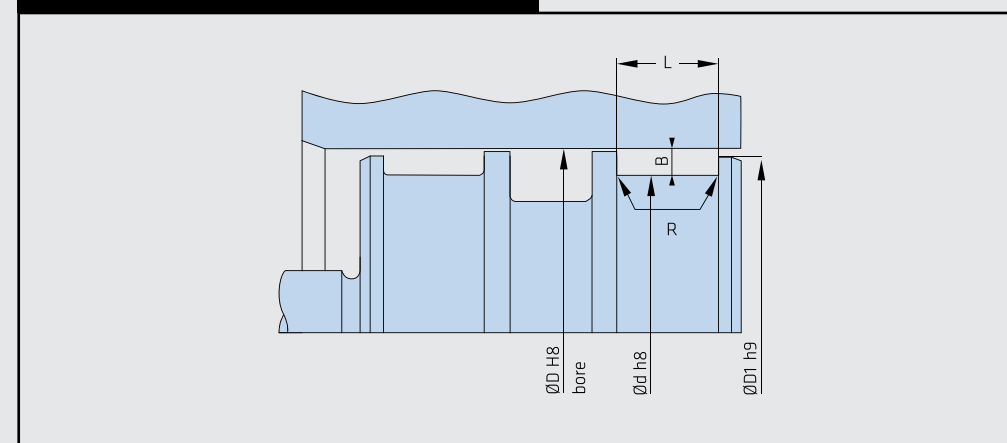

### WIPER

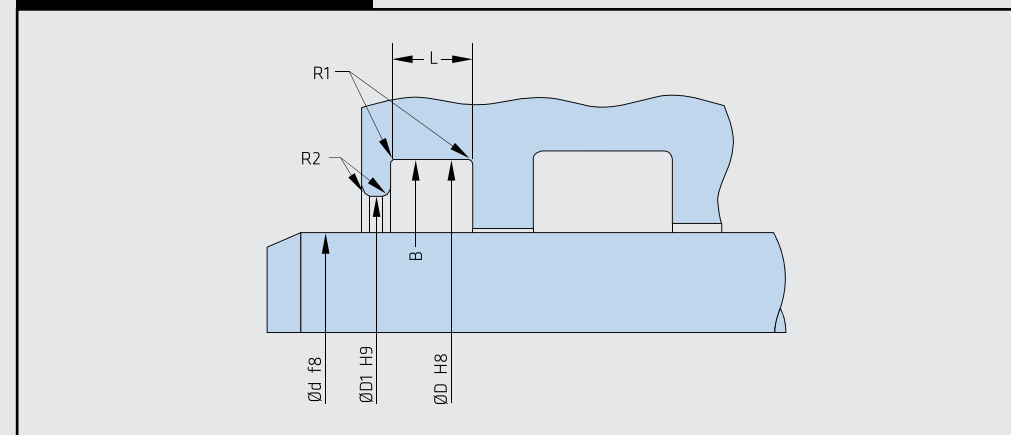

### GUIDE BAND - ROD

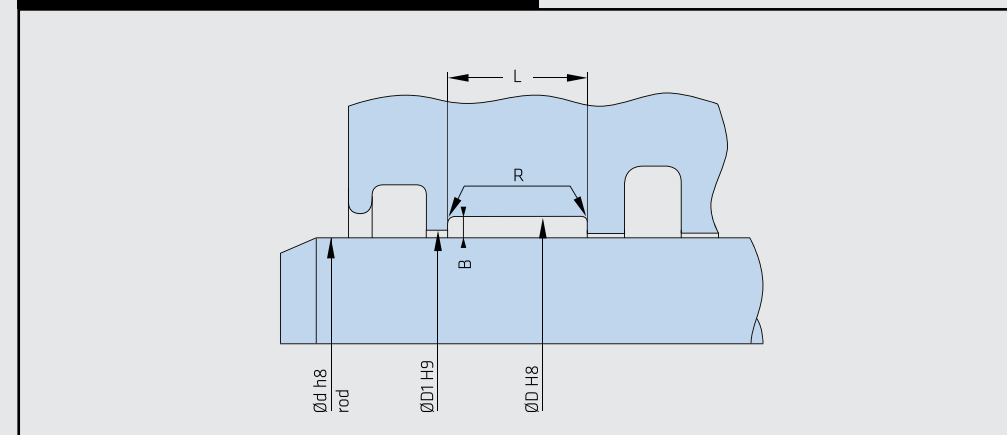

### ROTARY

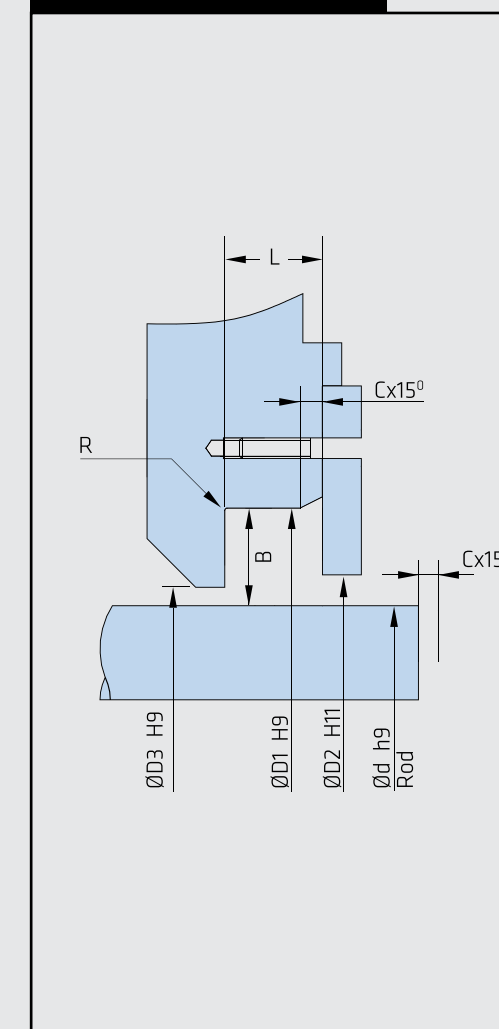

### FACE SEAL

